



NTI® NETWORK
TECHNOLOGIES
INCORPORATED

1275 Danner Dr Tel:330-562-7070
Aurora, OH 44202 Fax:330-562-1999
www.networktechinc.com

XTENDEX® Series

ST-C5HDMI-150

HDMI Digital Video and Audio Extender Installation and Operation Manual



TRADEMARK

XTENDEX is a registered trademark of Network Technologies Inc in the U.S. and other countries.

COPYRIGHT

Copyright © 2009 by Network Technologies Inc. All rights reserved. No part of this publication may be reproduced, stored in a retrieval system, or transmitted, in any form or by any means, electronic, mechanical, photocopying, recording, or otherwise, without the prior written consent of Network Technologies Inc, 1275 Danner Drive, Aurora, Ohio 44202.

CHANGES

The material in this guide is for information only and is subject to change without notice. Network Technologies Inc reserves the right to make changes in the product design without reservation and without notification to its users.

Note: CAT6 connection cable used between NTI XTENDEX Series Local and Remote or any XTENDEX Series products should not be run underground, outdoors or between buildings.

WARNING: Outdoor or underground runs of CAT6 cable could be dangerous and will void the warranty.

TABLE OF CONTENTS

Introduction.....	1
Materials.....	3
Features and Functions.....	4
Cable Connections.....	7
Daisy-Chaining.....	9
Interconnection Cable Wiring Method.....	10
LED Indications.....	10
Technical Specifications.....	11
Troubleshooting.....	12
Warranty Information.....	13

TABLE OF FIGURES

Figure 1- Connect the Remote to the Local with CAT6 cable.....	7
Figure 2- Connect AC adapter.....	7
Figure 3- Connect the remote unit to a display.....	7
Figure 4- Connect the Local unit to a video source.....	8
Figure 5- Daisy-chained Receivers.....	9
Figure 6- View looking into RJ45 female.....	10

INTRODUCTION

The XTENDEX® HDMI Extender transmits digital video and audio signals up to 150 feet using one CAT6 solid UTP cable. Each video extender consists of a local unit (transmitter) that connects to an HDMI source (Blu-Ray player, satellite receiver, etc.), and a remote unit (receiver) that connects to an HDMI display.

Optional:

Daisy-chain receivers allow you to extend one video source to multiple displays and to reach longer distances. The daisy-chain receivers are available in one-output daisy-chain and three-output daisy-chain options:

ST-C5HDMI-RD-150- Single-output daisy-chain remote unit

ST-C5HDMI-RD3-150- 3-output daisy-chain remote unit

Features:

- Ideal solution for digital signage applications.
- Transmits an uncompressed HDMI signal over one CAT6 cable.
- Supports HDTV resolutions up to 1080p and computer resolutions up to 1920x1200.
- Compliant with HDMI 1.2 and HDCP 1.1 standards.
- Supports the DDC2B protocol.
- Only one power supply is necessary to power both the local and remote units.
- Supports embedded digital audio through HDMI compatible TVs or audio receivers.
- Auto gain, auto skew, and auto EQ for plug-and-play setup and zero maintenance.

ST-C5HDMI-150 Local Unit (Transmitter)

- One female HDMI-A port for source connection.
- One female RJ45 port for sending high definition video/audio signals and DDC signal.
- Signal type: HDMI 1.2, HDCP 1.1 compliant.

ST-C5HDMI-150 Remote Unit (Receiver)

- One female HDMI-A port for HDTV or computer display.
- One female RJ45 port for receiving high definition video/audio signals and DDC signal.
- Refer to the resolution chart on page 11 for resolutions at different lengths.

Optional ST-C5HDMI-RD-150 One-Output Daisy-Chain Remote Unit (Receiver)

- Enables a daisy chain of five receivers at 1080p / eight receivers at 1080i/720p.
- One female HDMI-A port for HDTV or computer display.
- One female RJ45 port for receiving high definition video/audio signals and DDC signal.
- One female RJ45 port for sending high definition video/audio signals and DDC signal.
- Only every third receiver in daisy-chain needs power supply.

Optional ST-C5HDMI-RD3-150 Three-Output Daisy-Chain Remote Unit (Receiver)

- Enables a daisy chain of five receivers at 1080p / eight receivers at 1080i/720p.
- Each receiver supports three displays for a total of fifteen displays at 1080p and 24 displays at 1080i.
- Three female HDMI-A ports for HDTVs or computer displays.
- One female RJ45 port for receiving high definition video/audio signals and DDC signal.
- One female RJ45 port for sending high definition video/audio signals and DDC signal.
- Only every third receiver in daisy-chain needs power supply.

MATERIALS

Materials supplied with this kit:

- NTI ST-C5HDMI-150 Remote Unit (Receiver) and Local Unit (Transmitter)
- 110-220VAC, 50 or 60Hz-12VDC/2A AC Adapter
- This manual

Materials Not supplied but REQUIRED:

- CAT6 Solid unshielded twisted pair (UTP) cable(s) terminated with RJ45 connectors wired straight thru- pin 1 to pin 1, etc. (see page 10 for proper EIA/TIA 568 B wiring method)
- An HDMI-xx-MM HDMI male-to-male cable for the video source and another for the display to be connected to the extender. Cables are available from NTI where x= 3, 6, 14, 20, and 30 feet.

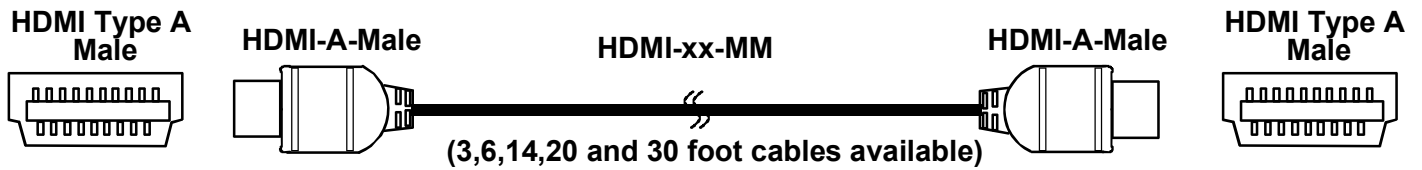

Also available from NTI are DVI-HDMI-x-MM DVI-D Single link male to HDMI male cables (where x- 3, 6, 10, and 15 feet)



Cables can be purchased from Network Technologies Inc by calling (800) 742-8324 (800-RGB-TECH) in the US and Canada or (330) 562-7070 (worldwide).

FEATURES AND FUNCTIONS

Top View of ST-C5HDMI-150 Remote Unit

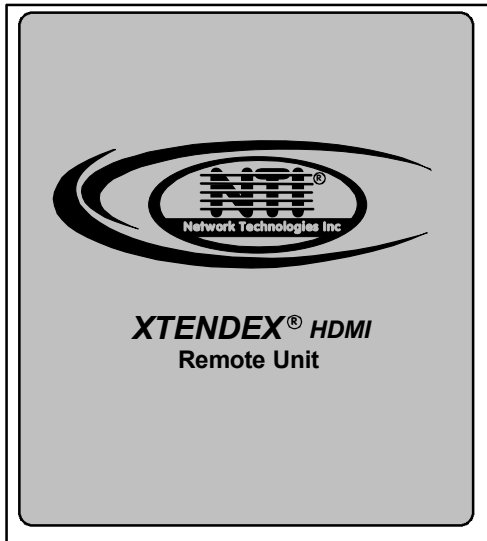

Top View of ST-C5HDMI-150 Local Unit

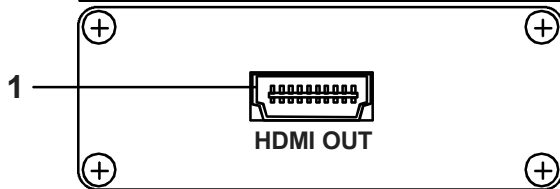
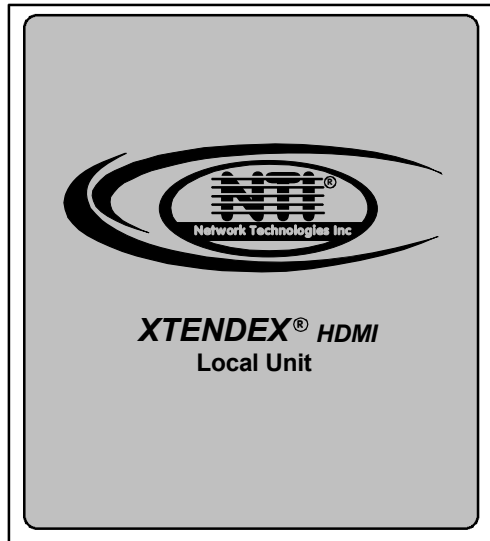

Front View of ST-C5HDMI-150 Remote Unit

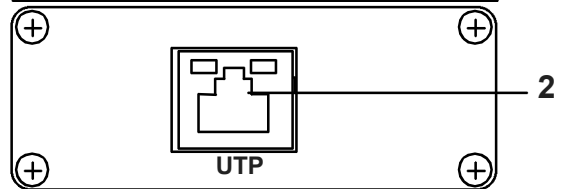

Front View of ST-C5HDMI-150 Local Unit

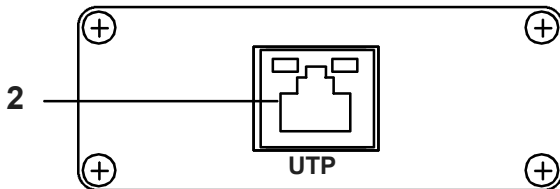

Rear View of ST-C5HDMI-150 Remote Unit

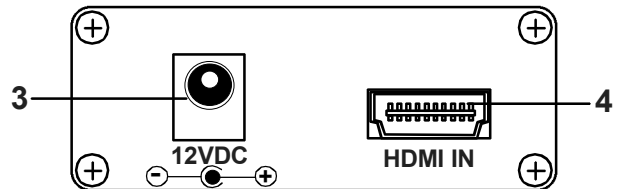

Rear View of ST-C5HDMI-150 Local Unit

1. **HDMI OUT**- HDMI female connector- for connection to HDMI cable from a display
2. **UTP**- RJ45 female connector- for connection of Unshielded Twisted Pair CAT6 cable between Remote and Local Units
3. **12VDC**- for connection of AC adapter
4. **HDMI IN**- HDMI female connector- for connection to HDMI cable from video/audio source

Top View of ST-C5HDMI-RD-150 Remote Unit

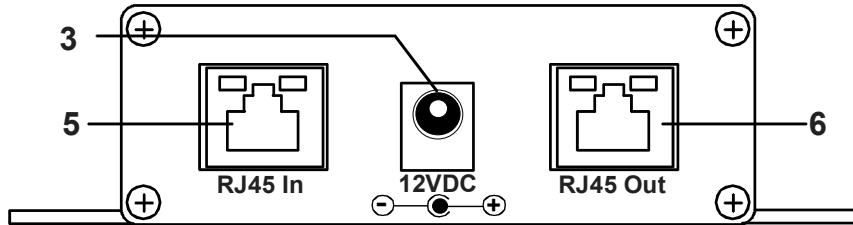

Front View of ST-C5HDMI-RD-150 Remote Unit

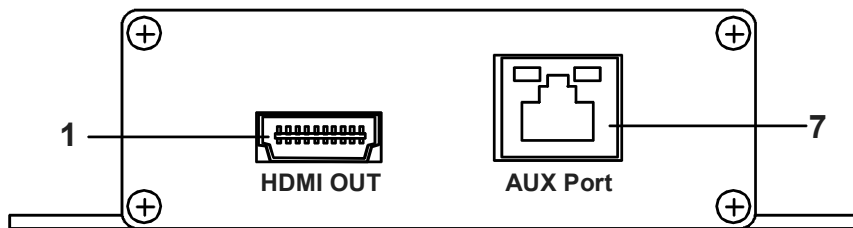

Rear View of ST-C5HDMI-RD-150 Remote Unit

- 5. **RJ45 In**- RJ45 female connector- for connection of Unshielded Twisted Pair CAT6 cable from a Local Unit or an upstream Remote Unit (Remote Unit closer in the daisy-chain to the Local Unit)
- 6. **RJ45 Out**- RJ45 female connector- for connection of Unshielded Twisted Pair CAT6 cable to a Remote Unit downstream in the daisy-chain
- 7. **AUX Port**- RJ45 female connector- NOT SUPPORTED AS OF THIS PUBLICATION

Top View of ST-C5HDMI-RD3-150

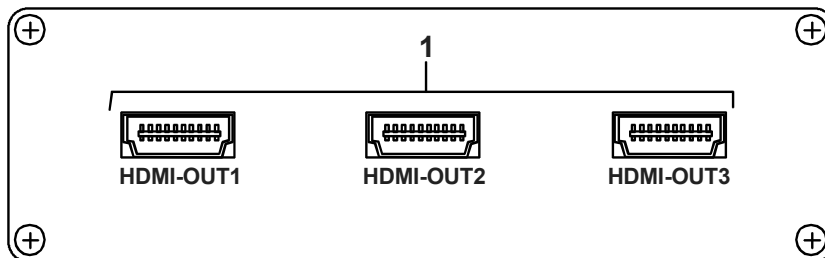
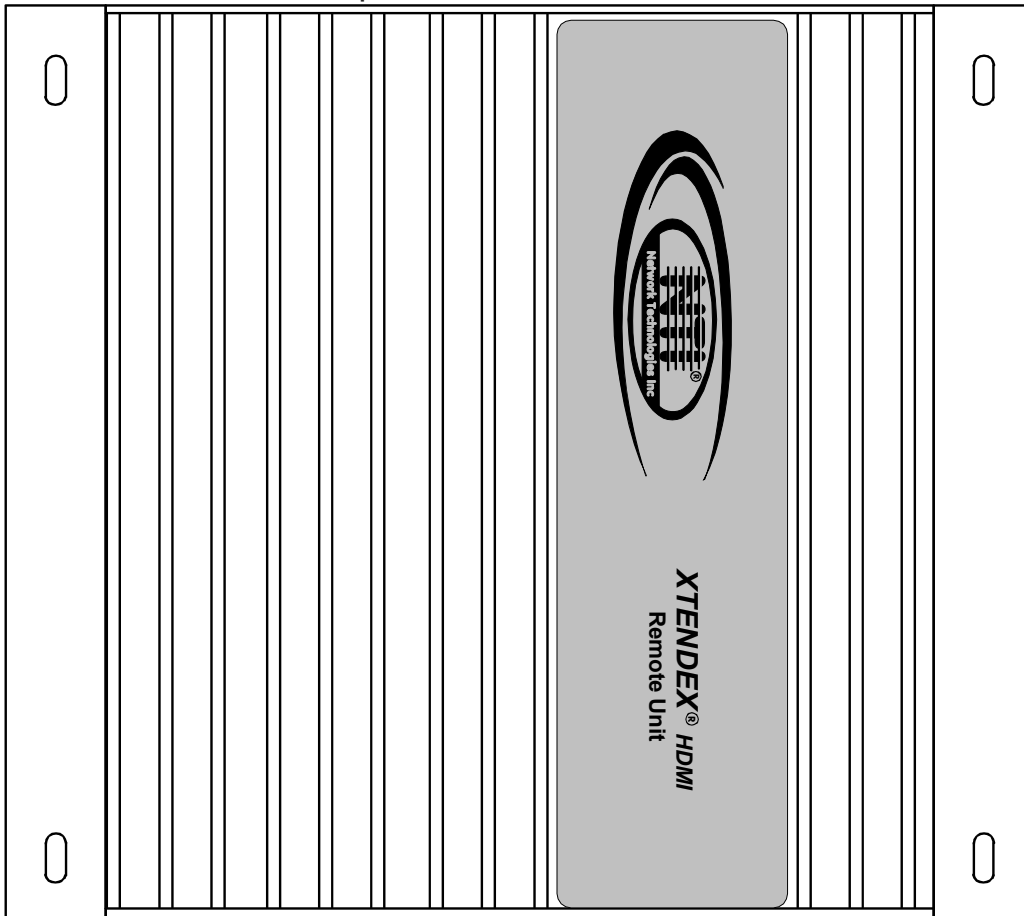

Front View of ST-C5HDMI-RD3-150

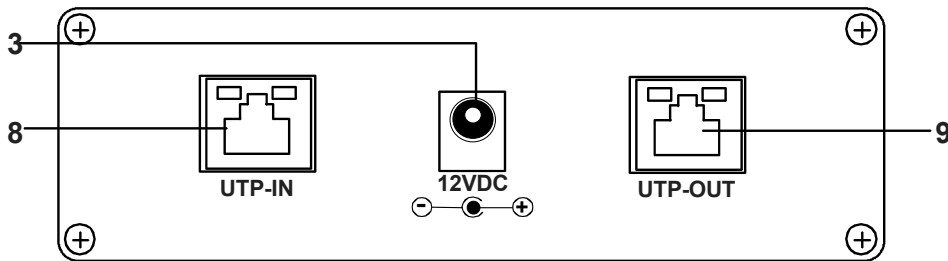

Rear View of ST-C5HDMI-RD3-150

- 8. **UTP In-** RJ45 female connector- for connection of Unshielded Twisted Pair CAT6 cable from a Local Unit or an upstream Remote Unit (Remote Unit closer in the daisy-chain to the Local Unit)
- 9. **UTP Out-** RJ45 female connector- for connection of Unshielded Twisted Pair CAT6 cable to a Remote Unit downstream in the daisy-chain

CABLE CONNECTIONS

1. Connect a CAT6 UTP cable (up to 150 feet) from the "UTP" port on the Local Unit to the "UTP" port on the Remote Unit.

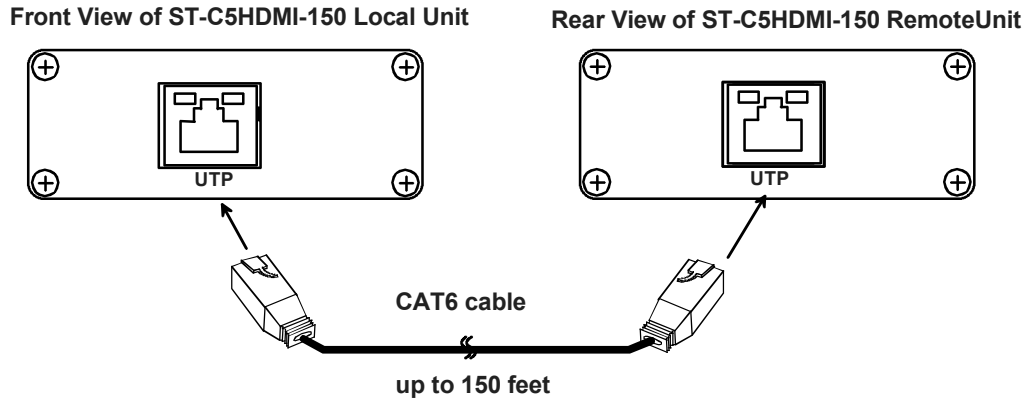

Figure 1- Connect the Remote to the Local with CAT6 cable

2. Connect the AC adapter to the Local unit and plug it into an AC receptacle.

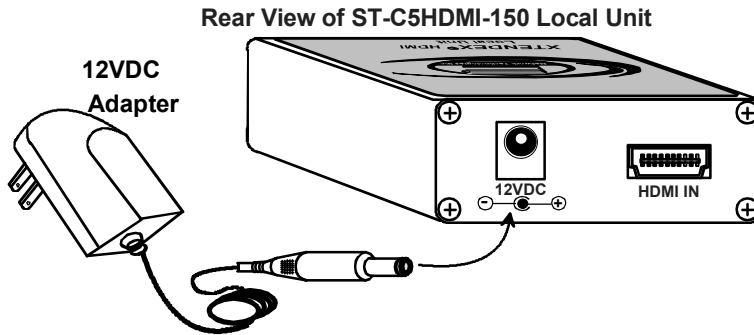

Figure 2- Connect AC adapter

3. Connect an HDMI-xx-MM cable between the "HDMI OUT" port on the Remote Unit and a display with an HDMI input and turn ON the monitor.

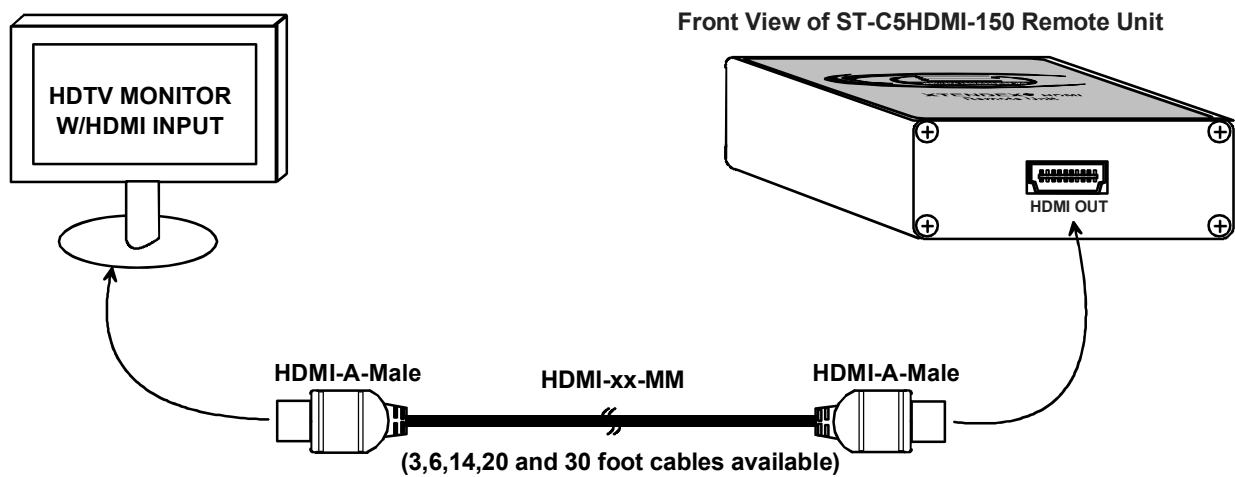

Figure 3- Connect the remote unit to a display

4. Connect an HDMI-xx-MM cable between the "HDMI IN" port on the Local Unit and the HDMI output of a video source.

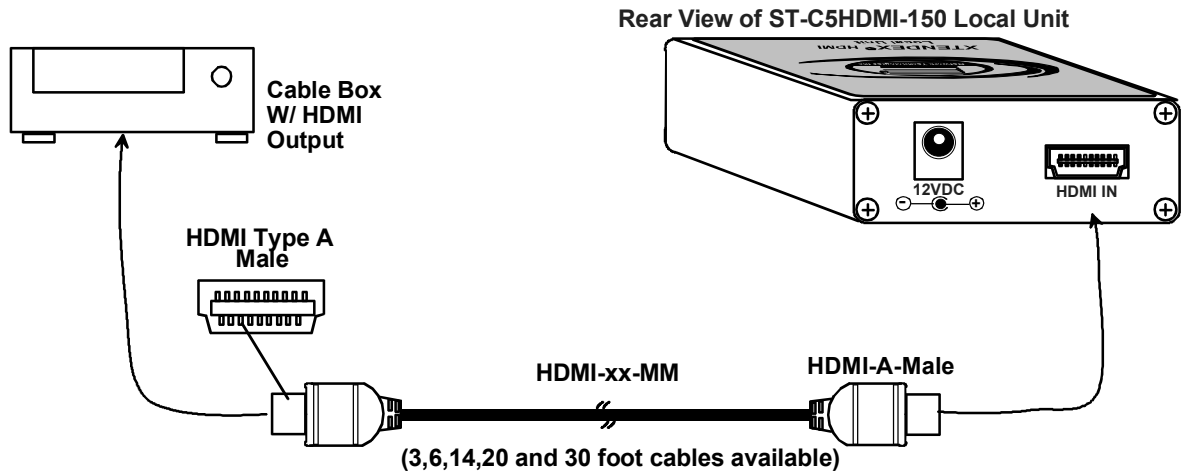

Figure 4- Connect the Local unit to a video source

DAISY-CHAINING

The NTI ST-C5HDMI-RD-150 and ST-C5HDMI-RD3-150 can be connected to a single monitor as described in the previous section and provides the option of connecting additional extenders. The ST-C5HDMI-RD3-150 remote unit can have up to 3 monitors connected in addition to daisy-chained extenders. Either remote unit enables up to five remotes to be daisy chained together at 1080p / or up to eight remotes at 1080i/720p.

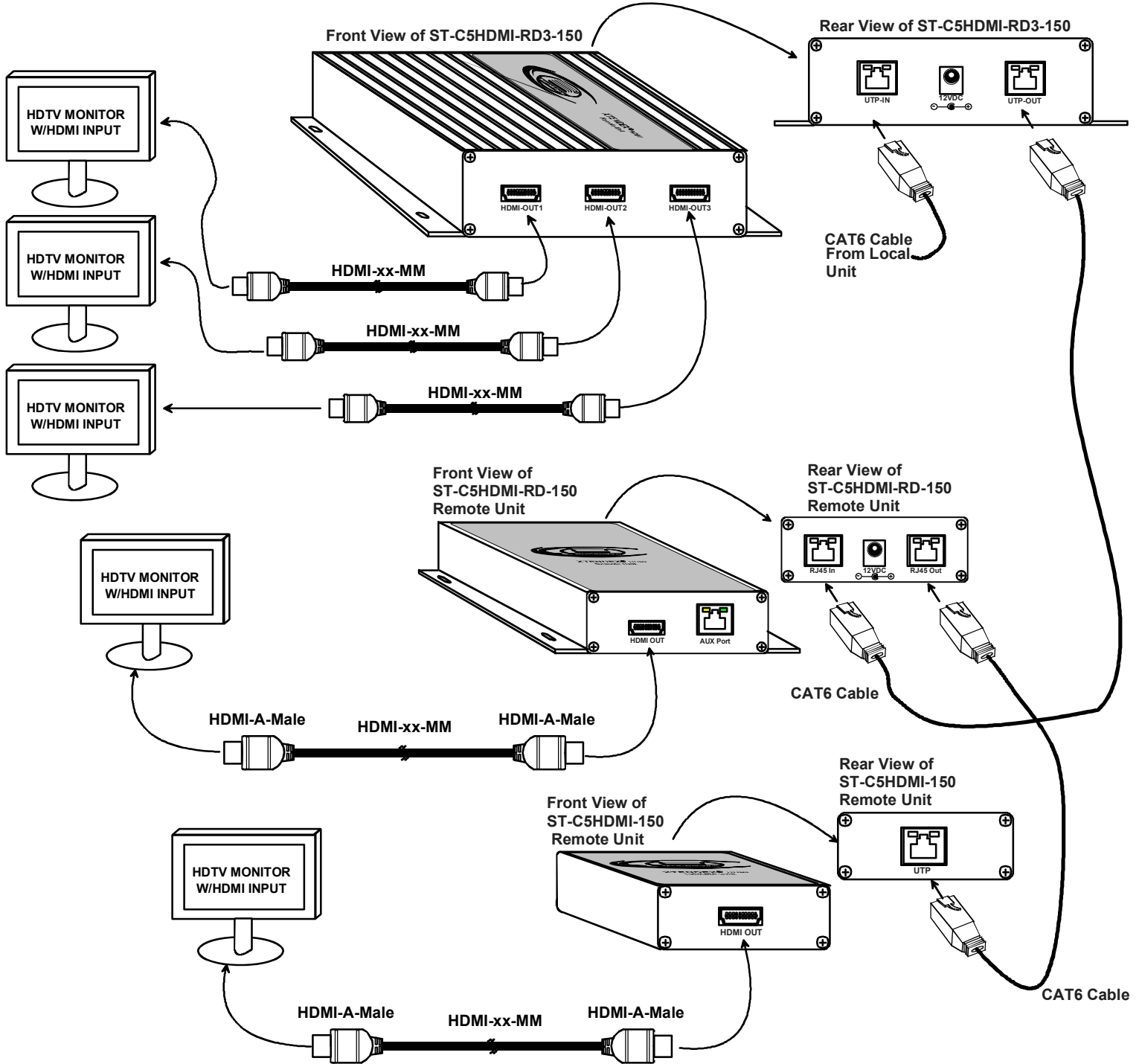

Figure 5- Daisy-chained Receivers

INTERCONNECTION CABLE WIRING METHOD

The connection cable between the remote and local is terminated with RJ45 connectors and must be wired according to the EIA/TIA 568 B industry standard. Wiring is as per the table and drawing below.

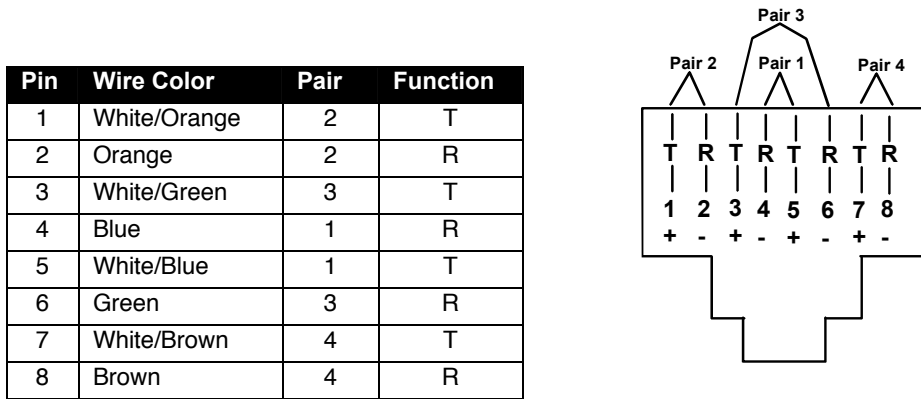

Figure 6- View looking into RJ45 female

LED INDICATIONS

The two LED's on the RJ45 connectors in this manual have the following meanings:

ST-C5HDMI-150 Transmitter: Left = Power ON,
Right = Transmitting

ST-C5HDMI-150 Receiver: Right = Power ON,
Left = Receiving HDMI signals

ST-C5HDMI-RD-150 Receiver:

“RJ45-In” (Left): Left = Power ON,
Right: Flashing = Waiting for the display ready;
Solid= Display is attached, EDID is validated, HDCP is active and working.

“RJ45-Out” (Right): Left = Receiving the HDMI signal from transmitter;
Right: Flashing =Waiting for the downstream receiver on the UTP port ready;
Solid = downstream receiver is attached to the ST-C5HDMI-RD-150, EDID is validated,
HDCP is active and working

ST-C5HDMI-RD3-150 Receiver:

“RJ45-In” (Left): Left = Power ON,
Right: Flashing = Waiting for any display on the HDMI port ready;
Solid = At least one display is ready on the three HDMI ports, EDID is validated, HDCP is active and working.

“RJ45-Out” (Right): Left = Receiving the HDMI signal from transmitter;
Right: Flashing =Waiting for the downstream receiver on the UTP port ready;
Solid = Downstream receiver is attached to the ST-C5HDMI-RD3-150, EDID is validated,
HDCP is active and working

TECHNICAL SPECIFICATIONS

Video bandwidth	4.8Gbps
Maximum Resolution	1080P/1920x1200 (see chart below)
HDMI Connector	Type A 19-pin female
Link Connector	RJ45 female
Signal Type	HDMI 1.2, HDCP 1.1 compliant
Cable required	CAT6 UTP solid 550 MHz or better cable with TIA/EIA-568B wiring terminated with standard RJ45 connectors is recommended for 1080p applications
Operating temperature	5°F to 122°F (-15°C to 50°C)
Storage Temperature	40°F to 185°F (-40°C to 85°C)
Storage Humidity	0% RH to 80% RH, non condensing
Operating Humidity	0% RH to 90% RH, non condensing
Power Supply	Local unit: 110 or 220 VAC at 50 or 60 Hz-12VDC\ 3A via AC adapter (included). Remote unit: powered from local unit via CAT6 solid UTP cable.
Power Consumption	Local unit: 6W; Remote unit: powered from local unit
Size (In.) WxDxH	
ST-C5HDMI-150	2.5x2.8x0.9 (local and remote unit)
ST-C5HDMI-RD-150	3.9x3.2x1.4
ST-C5HDMI-RD3-150	5x4.7x1.4
Approvals	RoHS, CE, FCC

Resolutions supported by Model ST-C5HDMI-150

Cable	Distance	Max. HDTV Resolution	Standard Resolution
CAT6-550MHz	150ft	1080p	1920x1200
CAT7-600MHz	200ft	1080p	1920x1200

TROUBLESHOOTING

Each and every piece of every product sold by Network Technologies Inc is 100% tested to exacting specifications. We make every effort to insure trouble-free installation and operation of our products. If problems are experienced while installing this product, please look over the information below to see if it can answer any questions that arise. If the answer is not found, please contact us directly for help at 1-800-742-8324 (800-RGB-TECH) in US & Canada or 1-330-562-7070 worldwide. We will be happy to assist in any way we can.

Frequently Ask Questions (FAQ's)

I'm getting no video on the display or one of the displays. What do I do?

First check to make sure the display supports the resolution by connecting the display directly to the source. (Note: if the direct connection does not work, then the HDMI connection or cable may have a problem.)

Secondly, check the CAT6 cable connecting the transmitter and receiver, the HDMI connections, then turn the power to the Local Unit OFF and back ON.

For best results, power OFF the video source, monitor and extender unit. Follow the sequence below:

1. Verify all connections
2. Disconnect source and monitor from the extender. Retain CAT6 cable connection.
3. Disconnect and reconnect the power adapter to extender and power it ON. Wait until the LEDs that indicate transmitting (Local Unit) or receiving (Remote Unit) stay on solid.
4. Connect the monitor with HDMI cable to the Remote Unit and power the monitor ON.
5. Connect the source with HDMI cable to the Local Unit and power the source ON.
6. The Local Unit and Remote Unit will start communicating with each other and will be transparent between the source and monitor. You will see the image from the source on the monitor.

Some Blu-Ray players work when connected directly to the HDTV, but do not work with the extenders.

The output format of source may be exceeding the total bandwidth capabilities (close to 10Gbps) of the extender. Try reformatting the source output by changing the color type (RGB or YPbPr), color scale (24 bits, 36 bits etc), frame rate, resolution or audio format.

Following formats may be tried for best performance:

1. 1080p/ 60Hz, 24bit color (standard), RGB or YPbPr
2. 1080p/ 24Hz, 36bit color (standard), YPbPr
3. 1080i, 48-bit color, RGB
4. 720p can work with all formats

What kind of CAT6 cable should be used?

CAT6 cable needs to meet/exceed UTP Solid 550MHz for satisfactory performance.

The picture blinks out sometimes, what do I do?

Blinking results from loss of sync between the source and display.

- Try to lower the resolution to see whether it solves the problem
- Or try reducing the CAT6 cable length.

WARRANTY INFORMATION

The warranty period on this product (parts and labor) is two (2) years from the date of purchase. Please contact Network Technologies Inc at **(800) 742-8324** (800-RGB-TECH) or **(330) 562-7070** or visit our website at <http://www.networktechinc.com> for information regarding repairs and/or returns. A return authorization number is required for all repairs/returns.

PRODUCT ST-C5HDMI-_____

SERIAL NO.: _____

DATE: _____ **INSPECTED BY:** _____

MAN116 Rev. 09/14/09